

Article number: 208050291

Description: E+G Sphericalwasher male DIN 6319-31-C-NI
Stainless Steel 1.4305

Measures

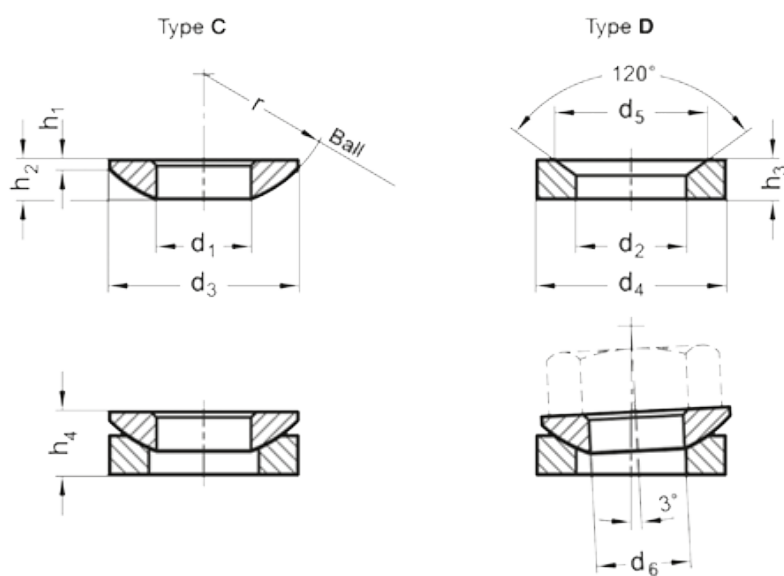

$d_1 = 31.0$

$d_3 = 56$

$d_6 = M30$

$H_1 = 3.6$

$H_2 = 11.2$

$H_4 = 19.2$

$r = 41$